

# Data Sheet



Article number: 107686

Description: Line choke 184420018  
for Vectron Active

## Measures

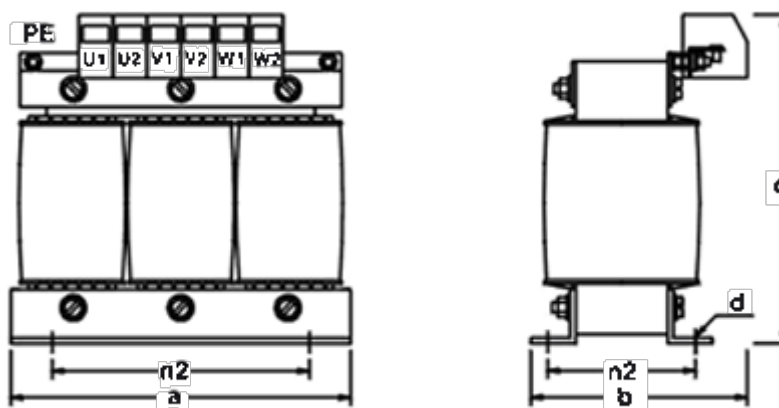

a = 155

b = 90

c = 135

d = 8

n1 = 57

n2 = 130

Weight (kg) = 4.0